

Instructions - User Manual

**ROBOT LAWNMOWER**

**RC800**



**ALNOVA<sup>®</sup>**

Millasur, SL.  
Rúa Eduardo Pondal, nº 23 - Pol. Ind. Sigüeiro  
15688 - Oroso - A Coruña - 981 696 465 - [www.millasur.com](http://www.millasur.com)



**ANOVA** thanks you for choosing one of our products and guarantees the assistance and cooperation that has always distinguished our brand over time.

This machine is designed to last for many years and to be of great use if used in accordance with the instructions contained in the user manual. We therefore recommend that you read this instruction manual carefully and follow all our recommendations.

For more information or doubts, you can contact us through our web supports such as [www.anova.es](http://www.anova.es)

## **INFORMATION ABOUT THIS MANUAL**

Please pay attention to the information provided in this manual and on the appliance for your safety and that of others.

- This manual contains instructions for use and maintenance.
- Take this manual with you when you go to work with the machine.
- The contents are correct at the time of printing.
- The rights to make changes at any time are reserved without affecting our legal responsibilities.
- This manual is considered an integral part of the product and must remain with it in case of loan or resale.
- Ask your dealer for a new manual in case of loss or damage.

## **READ THIS MANUAL CAREFULLY BEFORE USING THE MACHINE**



To ensure that your machine provides the best results, please read the usage and safety regulations carefully before using it.

## **OTHER WARNINGS:**

Incorrect use could cause damage to the machine or other objects.

The adaptation of the machine to new technical requirements could cause differences between the content of this manual and the purchased product.

Read and follow all instructions in this manual. Failure to follow these instructions could result in personal injury

# INDEX CONTENT

1. SAFETY RULES AND PRECAUTIONS
2. SAFETY SYMBOLS
3. PRODUCT DESCRIPTION
4. TECHNICAL DATA
5. INSTALLATION
6. SETTINGS
7. TROUBLESHOOTING - ERROR CODES
8. SOFTWARE UPDATE
9. MAINTENANCE
10. CONNECT APP
11. ENVIRONMENT
12. WARRANTY CONDITIONS
13. EXPLODED
14. CE CERTIFICATE

# 1. SAFETY RULES AND PRECAUTIONS

## General

- This annex presents safe operating practices for this type of machines which comply with the regulations.
  - It should also include information on noise levels and necessary warnings, along with the following points.
- ⚠ Important: Please read the manual carefully before using the machine. Keep these instructions for future reference. Due to our ongoing R&D&I program, the specifications in this document are subject to change without notice.

## Safe operating practices

### Training

- Read the instructions carefully. Become familiar with the controls and the proper use of the machine.
- Never allow people who are not familiar with these instructions or children to use the machine. Local regulations may restrict the age of the operator.
- The operator and/or user is responsible for accidents or dangers that occur to other people or their property.

### Preparation

- Make sure to correctly perform the installation of the automatic perimeter delimitation system according to the instructions.
- Make sure your grass is no longer than 4" or 100mm, if it is longer use a regular lawn mower or grass trimmer to cut it.
- Periodically inspect the area where the machine will be used and remove all stones, sticks, wires and other foreign objects.
- Periodically inspect the blades, blade bolts and components of the robotic lawnmower for wear and damage. Replace worn or damaged blades and bolts in sets to preserve balance.
- On multi-spindle machines, be careful as turning one blade can cause other blades to rotate.

## Operation and commissioning

### General

- Never use the machine with faulty guards or without safety devices.
- Do not put hands or feet near or under rotating parts. Stay clear of discharge opening at all times.
- Never lift or carry a machine while the engine is running.
- Shut down and stop the machine completely:
  - Before removing any jam
  - Before repairing or adjusting the machine
- Do not leave the machine running unattended if you know there are pets, children or people in the vicinity.

## Maintenance and storage

- Keep all nuts, bolts, and screws tight to ensure the machine is in safe operating

condition.

- Check the robotic lawnmower frequently to see if it is worn or damaged.
- Replace worn or damaged parts for safety.
- Be sure to charge the battery with the correct charger recommended by the manufacturer. Improper use may lead to electric shock, overheating, or leakage of corrosive liquid from the battery.
- Maintenance of the machine must be carried out in accordance with the manufacturer's instructions.

## **Battery pack and charger**

Before charging, please read the instructions.

- Please make sure your charger matches the outlet, make sure the connection between battery charger and battery pack is correct model.
- Longer life and better performance can be obtained if the battery pack is charged when the air temperature is between 18°C and 25°C.
- Do not charge the battery in ambient temperatures below 5°C or above 40°C. This is important as it can prevent serious damage to the battery.
- Be careful with batteries. In case of electrolyte leakage, rinse with water/neutralizing agent, and also seek medical help if it comes into contact with eyes, etc.

### Battery Pack Safety Warnings

- Do not disassemble, open or crush the battery pack.
- Do not short circuit the battery pack.
- Do not store battery packs haphazardly in a box or drawer where they can short-circuit each other or be caused by conductive materials.  
When the battery pack is not in use, keep it away from other metal objects, such as paper clips, coins, keys, nails, screws, or other small metal objects, that can make a connection from one terminal to another. Shorting the battery terminals can cause burns or fire.
- Do not expose the battery pack to heat or fire. Avoid storage in direct sunlight or high temperatures.
- Do not subject the battery pack to mechanical shock.
- In the event of battery leakage, do not allow the liquid to come into contact with skin or eyes. If contact has been made, flush affected area with plenty of water and seek medical advice.
- Keep the battery clean and dry.
- The battery pack offers its best performance when operating at normal room temperature (20°C ± 5°C).
- Do not use modified or damaged batteries.
- Recharge only with the charger specified by the manufacturer. Do not use any charger other than the one provided specifically for use with this machine. A charger not approved by the manufacturer for this battery pack may create a risk of fire and related injury.
- Do not use any battery pack that is not designed for use with the equipment.
- Keep the battery pack out of the reach of children.
- Please retain the original product documentation for future reference.
- Properly dispose of the battery pack and charger following environmental safety regulations.
- If the appliance is to be stored unused for a long period of time, the batteries should be removed.

## 2. SAFETY SYMBOLS

### General



Warning: Read the user instructions before using the product.



Warning: Deactivate the product before working or lifting the machine.



Warning: Keep a safe distance from the machine when it is in operation. Keep hands and feet away from rotating blades.



Warning: Do not climb on the machine. Never put your hands or feet near or under the machine.



Use a detachable power supply as defined on the rating label next to the symbol.



CE conformity mark.



Noise emission to the environment. The emissions of the product are indicated in the Technical data and on the nameplate.



The low voltage cable must not be shortened, lengthened or spliced. Do not use the robotic lawnmower near the low voltage cable. Take care when trimming the edges where the cables are placed.



Disposal of this product as normal household waste is not permitted. Make sure the product is recycled in accordance with local legal requirements.

### Symbols on the battery pack



Read the user instructions.



Do not throw the battery into a fire and do not expose it to a heat source.



Do not immerse the battery in water.







Recyclable brand.



Disposal of this battery pack as normal household waste is not permitted. Make sure the battery is recycled in accordance with local legal requirements.

## Symbols on the charger

	Read the user instructions.
	SMPS (Switch Power Supply Unit)
	Double insulation.
	SMPS (power supply unitswitched) that incorporates a switching power supply with short-circuit proof safety isolation.
	Disposal of this battery pack as normal household waste is not permitted. Make sure the battery is recycled in accordance with local legal requirements.

**⚠ Warning:** Read all safety warnings and instructions. Failure to follow the warnings and instructions may result in electric shock, fire, and/or serious injury. Please read the instructions for the safe operation of the machine carefully, save all warnings and instructions for future reference.

## 3. PRODUCT DESCRIPTION

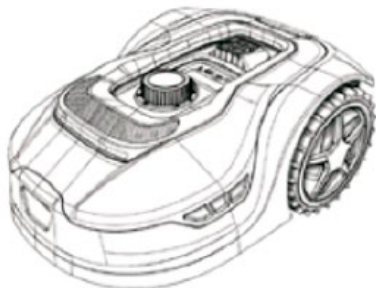

Robotic lawnmower

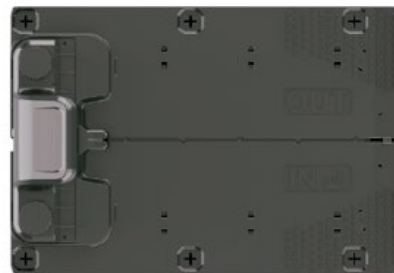

Charging cradle



Base fastening pegs



Spare blades



Perimeter cable reel



Pegs



Charger



Guide away

You will also need:



## 4. TECHNICAL DATA

Model	RC800 (RMA801M20V)
Cutting area	800m <sup>2</sup>
Voltage	20V max.
No load speed	2800rpm±100rpm
Cutting diameter	180mm
Cutting height	20-60mm
Height-of-cut positions	9
Maximum angle for the work area	36% (20°)
Narrowest passage possible	0.8m
Battery type/model	5.0Ah Li-Ion
Charger time	90-100min
Charger Rating	Input: 100-240V 50/60Hz, 76W Output:20.5V--3.0A(IP67)
Noise (sound power) <i>(2000/14/EC modified by 2005/88/EC, Annex V)</i>	<62Db
Weight	8.2kg
Perimeter wire	170m
Pegs	230pcs
Blades	3pcs
Charging cradle	1 (RC500-01 / CB03A)
Batteries	1 (LBF205)
Charger	1 (CGF253)
Robot protection	IPX5
Charging station protection	IPX4
Power supply protection	IP67
Apps	Wi-Fi 2.4G + Bluetooth 4.0

### Clarifications:

- Not all accessories that are described in this manual have to be included in the final delivery of the product due to product updates.
- Measured no-load voltage: The initial battery voltage reaches a maximum voltage of 20 volts. The nominal voltage is 18 volts.
- We recommend that you purchase the original accessories from the same store that sold



you the tool. See the accessory packaging for details. The store staff can help you and offer advice.

Label:



## 5. INSTALLATION

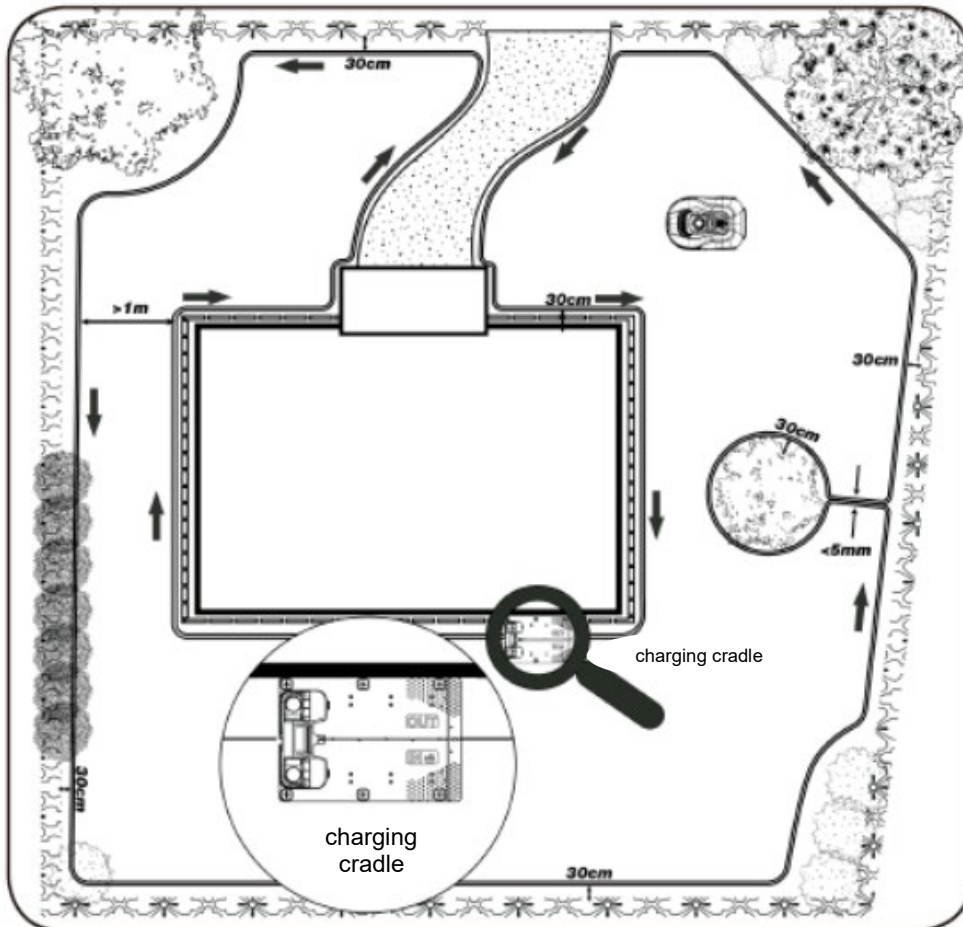

## Installation of the charging base

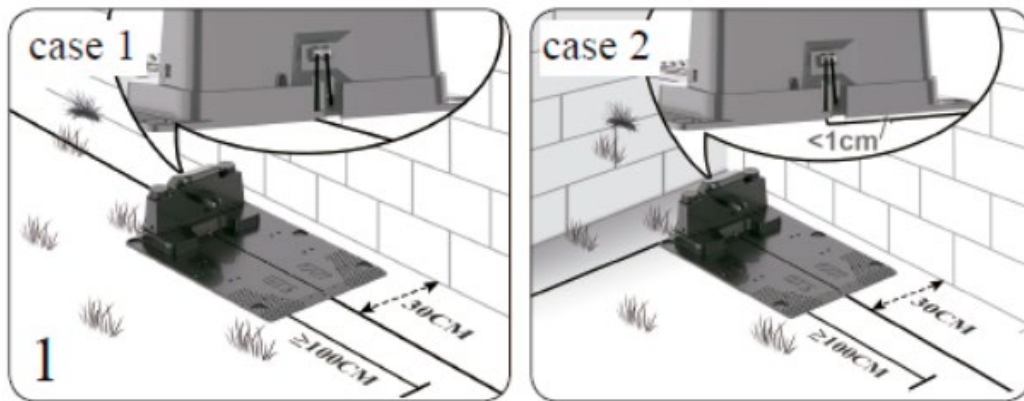

- The charging base can be placed near the house. When laying the perimeter wire, leave at least 1m of straight wire without obstacles in front of the charging base.  
Note: The front of the perimeter wire of the charging base must be straight for 1m without corners or obstacles to ensure proper docking of the product.
- The charging base must be placed on level ground. It should not be placed on a slanted surface or anywhere that will cause your plate to bend.
- The charging station must be placed on relatively level ground. It should not be placed on a slanted surface or anywhere that will cause your plate to bend.
- We recommend that the power supply is placed on the wall at a minimum height of 30 cm and that the power cable is outside the working area of the robotic lawnmower. If not, you can bury it if you wish.
- The perimeter wire should be stripped about 10mm at one end.

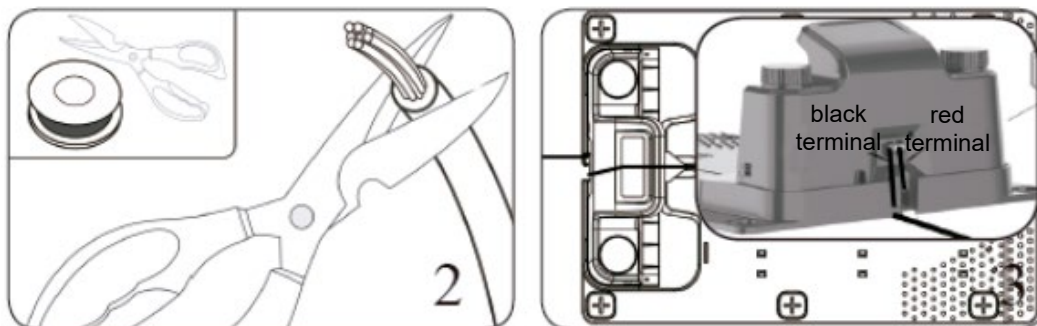

- Insert the perimeter wire terminal (RED) into the OUT side, then the perimeter wire through the slot under the charging base plate.
- When laying the perimeter wire in the work area, cut off the unnecessary wire, strip the perimeter wire about 10mm at the other end, insert the other wire terminal (black) to the IN side.

## Perimeter Wire Installation

- When laying the perimeter wire, use the distance gauge to keep a 30cm gap between the wire and the perimeter. Each peg should be placed about 80cm apart, use the gauge to ensure proper installation. The work surface is usually an irregular area, the distance between pegs can be reduced as appropriate for the type of perimeter and terrain.  
NOTE: The maximum length allowed for the perimeter wire is 300 m.

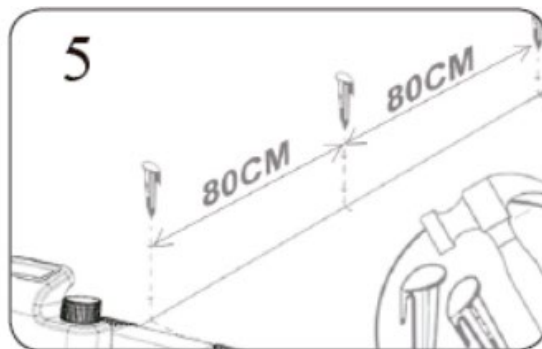
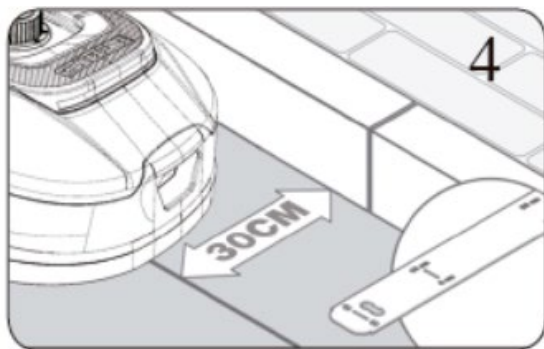

- If an obstacle is level with the ground and it is safe for the robotic lawnmower to drive over it, such as a driveway or sidewalk, only 8 cm of space is needed between it and the perimeter wire.

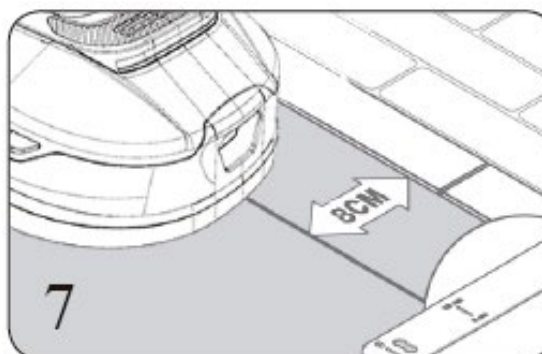
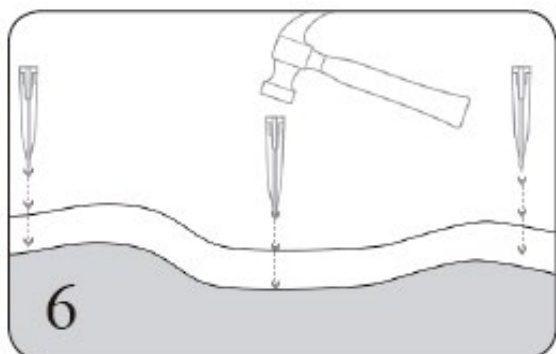

- Configuration requirements for islands and aisle sizes: yes! do not want the robotic lawnmower to go to an area such as; flowers, bushes or trees, you can place a perimeter island for those elements of your garden. You can see the example mounting type in figure 8.

As shown in figure 9, the robotic lawnmower can pass through a narrow passage up to 0.8m wide.

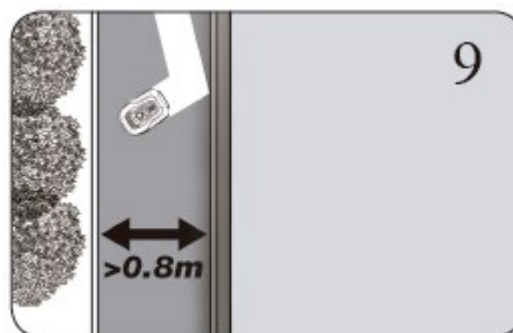
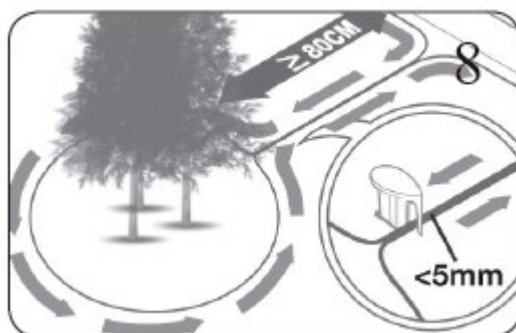

- Make sure the Perimeter Wire is perfectly straight at every corner and that all angles made by the Perimeter Wire are 90° or greater. Avoid very sharp angles in the installation.

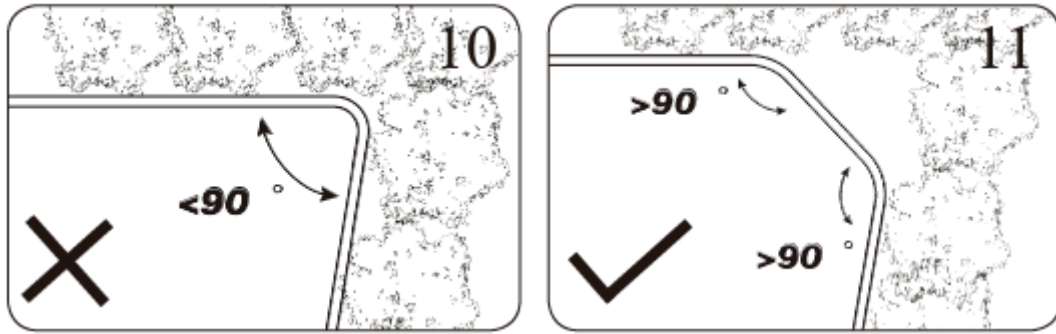

- Slopes: Your robotic lawnmower has the ability to safely climb slopes up to 35% (20°), so areas steeper than this should be avoided. How to calculate the slope of your lawn: Lay the perimeter wire on slopes as shown in figures 12 and 13.

Note: \*A: Upper Perimeter Wire / B and C: Lower Perimeter Wire

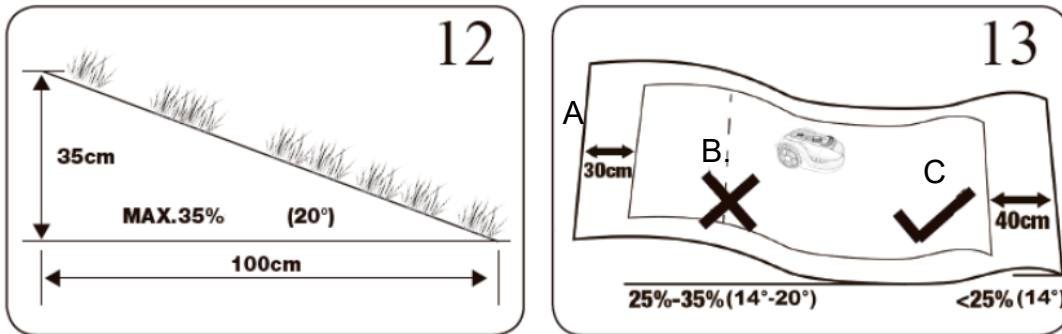

## Connecting the charging base to the power supply

Plug the charging base into the power supply, which in turn must be connected to an outlet in your home. The LED light on the charging base indicates the battery status. You can then check the meaning of each LED light to ensure that the connection is correct.

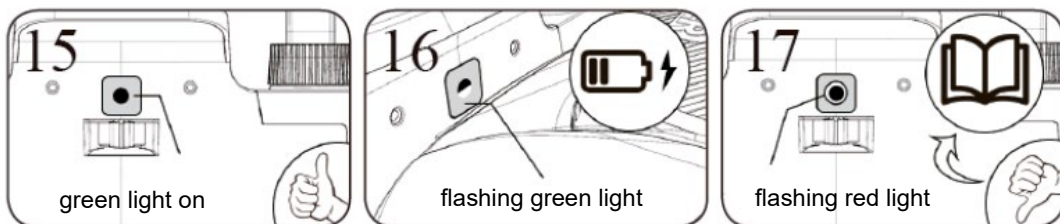
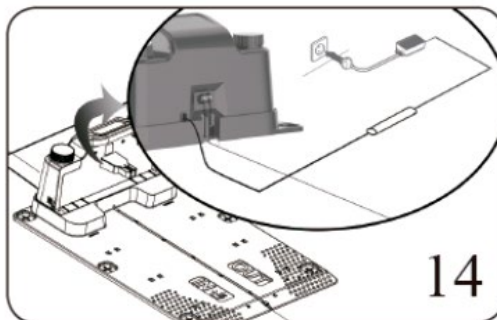

LED light status	Possible meaning	Action
It does not turn on	no current	Confirm that the power cord is properly connected to the charger and that the charger is connected to a suitable power source.
Green light on	The perimeter wire is connected to the right; the robotic lawnmower is fully charged	NA
flashing green light	The robotic lawnmower is charging correctly	NA
flashing red light	Perimeter wire is not connected Perimeter wire is broken	Check that the two ends of the perimeter wire are connected correctly. Check that the perimeter wire is not broken.

## Installation check

- Set the cutting height to its maximum level (60 mm) for the first cut.
- Place your robotic lawnmower inside the work area, work for a while, then check the perimeter wire properly.
- Check if the robotic lawnmower returns to the charging station along the perimeter wire.
- If it returns to the charging base successfully, the installation has been completed successfully.

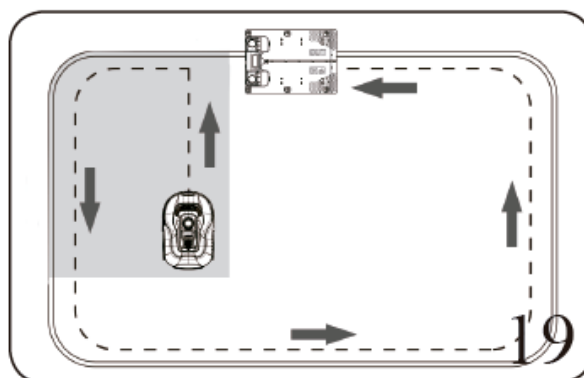
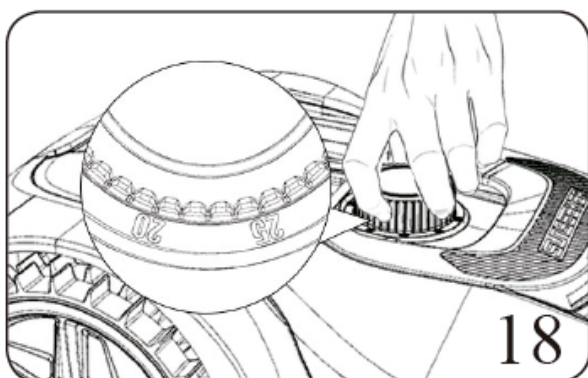

## 6. SETTINGS

### Robotic lawnmower quick setup guide

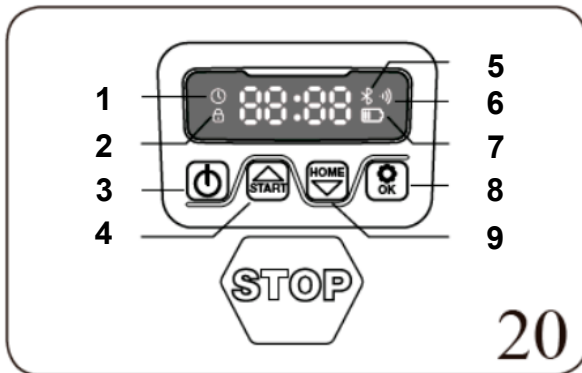

1. Date settings icon
2. Password setting icon
3. Power on/off
4. Start work/ Upload
5. Bluetooth
6. Wi-Fi
7. Battery icon
8. Confirm (OK)
9. Return to the station / Get off

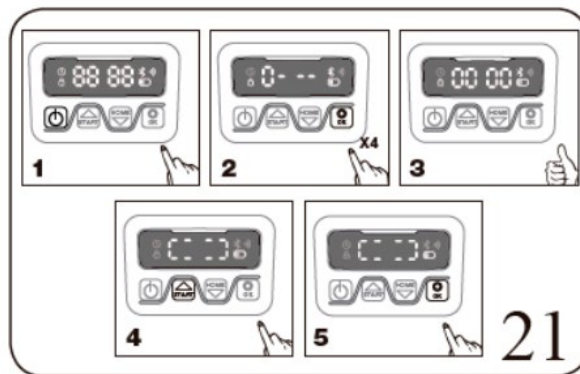

- 1) After the installation of the perimeter wire, you can start using the robotic lawnmower.
- 2) Press the on/off button (3) until the robotic lawnmower turns on. For the first use, enter the default PIN code 0000 by pressing four times when the number 0 is flashing. The PIN code can be changed, see the following configuration section.  
Note: The robotic lawnmower will turn off if it does not receive any input within 30 seconds after it is turned on. If an incorrect PIN code is entered ten times, the robotic lawnmower will give an audible alarm and then turn off.
- 3) Press , then press to start mowing the lawn.
- 4) Press and then for the robot to return to the charging station.



The robotic lawnmower will run continuously until it reaches low battery power level and then it will return to the charging base. After charging is complete, the robotic lawnmower will automatically resume mowing or stay on the charging base according to the mowing schedule.

### Change PIN code

To change the PIN code:

- Hold down the buttons Y at the same time for 3 seconds.
- The icon will flash, "PIN 1" will flash, that means you need to enter the old PIN. After "PIN 1" is displayed, the first number will flash.
- use either to select the number and press to confirm. The next number will flash.
- Use the same method to enter your old PIN. Now you can set your new PIN.
- For example, the new PIN code is set to be 1234. After you enter your old PIN, "PIN2" will flash and the first number will flash again. Use the same method to enter your new

desired PIN code (in this example, 1234).





- Then it will appear   on the screen. Your PIN code has been changed successfully.



*\*Note: For reference only*













## Set year, date and time

Setting the year, date, and time are required setup items. If you do not set these items, it will influence the scheduling time in the following settings. These items must be set in the order of year, date, and time. For year setting:



- For year setting, press and hold  for 5 seconds until the icon  and a number flash on the screen, for example, 2020.
- use  either  to select the year you want.
- Then press  to confirm and finish the year setting.







*\*Note: For reference only*

- Meanwhile, the icon  it will flash again and a number will be displayed to indicate the date, for example, 08.25, which means August 25.
- When  is flashing, use  either  to select the number and press  to confirm. Then finish the date setting.
- Meanwhile, the icon  will flash and the time will be displayed, for example, 13:25. When  is flashing, use  either  to select the number and press  to confirm.
- Now that the time setting is complete, the display will show  .

## Change the default start time

The default start time of 9:00 can be changed to any time by pressing the buttons    at the same time for 3 seconds.





For example, if you want to change the time to 1:25 p.m., when  blink:

- use  either  to select the number and press  to confirm.
- Later   will appear on the screen and your mower will start mowing from 13:25, at the same time you will hear a beep.



## Change the default cutoff time per day





The default cutoff time is 8 hours per day, you can change it to 1-24 hours.

- Hold down the buttons  for 3 seconds
- For example, if you want to change to 06h, when **08 H** blink, use  either  to select the number and press  to confirm. then it will show **06 H** on the screen.
- Then your robotic lawnmower will mow 6 hours per day, at the same time you will hear a beep.



























## Change the default cutoff time per week

The default cutoff time per week is 5 days, but can be changed to 3 or 7 days.

- Hold down the buttons  Y  for 3 seconds.
- For example, change to 3 days per week:
  - – 05 – will flash, use  either  to select the number and press  to confirm.
  - Then **03 D** will be on the screen.



## 7. TROUBLESHOOTING – ERROR CODES

Display	Meaning	Actions
F1	Rain delay on	No action is required
E1	Robotic lawnmower outside the working area	<ol style="list-style-type: none"> <li>1. Check if the robot is inside the work area, if it was:</li> <li>2. Check if the charging base is properly connected to the charger and if the charger is connected to a suitable power source; if they are connected correctly, the perimeter wires may be attached incorrectly and need to be reversed.</li> </ol>
E11	no limit sign	<ol style="list-style-type: none"> <li>1. If the robot is inside the work area, check the LED light on the charging station, if it turns red, it means that the perimeter wire was not properly connected to the clamps on the charging base. If it was securely attached to the clamps and the LED still turns red, check to see if the perimeter wire is broken.</li> </ol>
E2	wheels are locked	<ol style="list-style-type: none"> <li>1. Turn off the robot and take it to an area free of obstacles.</li> <li>2. turn it on Press  and then .</li> <li>3. If the error message is still displayed, turn it off; turn the mower over and check for anything preventing the wheels from turning.</li> <li>4. Remove any obstructions, place the robot in working position and switch it on. Press  and then .</li> </ol>
E3	Knife disc locked	<ol style="list-style-type: none"> <li>1. Turn off the mower.</li> <li>2. Turn the mower over and check if there is anything preventing the blade disc from turning.</li> <li>3. Remove any obstruction.</li> <li>4. Put the robot in working position and move it to an area with short grass or adjust the cutting height.</li> <li>5. Switch on the robotic lawnmower. Press  and then .</li> </ol>
E4	Obstruction Sensors Trigger Not Retrieved	<ol style="list-style-type: none"> <li>1. Switch off the robotic lawnmower.</li> <li>2. Move the robotic lawnmower to an area of your lawn that is free from obstacles.</li> <li>3. Remove the float cover and check the cylindrical magnet on the float cover. If there is no magnet, replace the floating cover.</li> <li>4. Turn on the power. Press  and then .</li> </ol>
E5	The robotic lawnmower is raised	<ol style="list-style-type: none"> <li>1. Switch off the robotic lawnmower.</li> <li>2. Move the robotic lawnmower to an area of your lawn that is free from obstacles.</li> <li>3. Switch on the robotic lawnmower. Press  and then .</li> <li>4. If the error message is still displayed; turn it off; turn the robot over. Check if there is anything preventing the front wheel axle from slipping.</li> <li>5. Remove any obstructions, place the robotic lawnmower in working position and switch it on. Press  and then .</li> </ol>
E6	The rollover sensor has been activated	<ol style="list-style-type: none"> <li>1. Bring the robotic lawnmower into working position. Press  and then .</li> </ol>
E7	Tilt sensors have been activated	<ol style="list-style-type: none"> <li>1. Switch off the robotic lawnmower.</li> <li>2. Take the robotic lawnmower to flat ground on your lawn.</li> <li>3. Switch on the robotic lawnmower. Press  and then .</li> </ol>
E8	Failed charging connection	<ol style="list-style-type: none"> <li>1. Check that the perimeter wire on each side of the charging base must be straight for 1 m without any corners or obstacles to ensure proper docking.</li> <li>2. The charging station must be placed on relatively level ground. It should not be placed on a slanted surface or anywhere that will cause your plate to bend.</li> <li>3. Manually dock the robotic lawnmower on the charging base to charge it. After the robot is fully charged, press  and then .</li> </ol>
BP	Battery temperature protection	<ol style="list-style-type: none"> <li>1. Check battery temperature. The temperature is too high, please wait until the temperature has cooled down. If the temperature is too low, please wait until the temperature is <math>&gt;5^{\circ}\text{C}</math>, press  and then .</li> <li>2. If the error message is still displayed, please replace a new battery. Restart the robotic lawnmower. Press  and then .</li> <li>3. If the error occurs repeatedly, please contact your official dealer for help.</li> </ol>
EE	unknown error	<ol style="list-style-type: none"> <li>1. Restart the robotic lawnmower. Press  and then . If the error message is still displayed, please contact your official dealer for help.</li> </ol>

⚠Attention: If the error is not corrected with the above measures, try restarting the unit. If the error still continues, contact your nearest Anova dealer.

## 8. SOFTWARE UPDATE

The software can be updated when new versions are available. The latest software will be provided through your official Anova reseller.

## 9. MAINTENANCE

Your robotic lawnmower needs regular maintenance and cleaning. Also, some parts will require replacement as they wear out.

Turn off the machine before performing any service or maintenance to ensure your safety.

### Blade sharpening maintenance

⚠Warning: Before cleaning, adjusting or replacing the blades, switch off the robotic lawnmower and put on the necessary PPE such as protective gloves or similar.

⚠Warning: When fitting new blades, be sure to replace all blades. It is not mandatory to replace all the screws if they are in good condition, if the screw has been damaged or cannot be fixed then you need a new screw to mount the blade. This is important to ensure blade retention and to balance the blade's rotating disk. Failure to use new screws could result in serious injury.

- Each cutting blade has an estimated duration of 2 months when a daily cut is scheduled. Always check to see if the blades are broken or damaged and replace them if they are.
- When the mowing blades become dull and worn, they should be replaced with the replacement blades supplied with your robotic lawnmower.
- Replacement blades are also available from your official Anova dealer.

⚠Important: After screwing the blades to the cutting deck, make sure the blade can rotate freely.

### Cleaning

⚠Warning: Before cleaning, turn off your robot. Put on protective gloves before cleaning the cutting deck.

Note: You can clean with low pressure water (<1Mpa)

### Storage

Your ride-on mower will have a longer life if it is stored properly and not used during the winter. Before preparing your robotic lawnmower for storage, we recommend that you:

- Thoroughly clean your robotic lawnmower.
- Fully charge the battery and remove it from the robotic lawnmower.
- Turn off the power.

⚠Warning: Protect the bottom of the robotic lawnmower from water. Do not store the robotic lawnmower upside down outdoors.

## Replacing the battery

**⚠ Warning:** Power off before attempting any adjustments, replacements, or repairs. Before replacing blades, turn off your mower and put on protective gloves.

If you need to replace the battery, follow these steps:

- Turn your robotic lawnmower upside down.
- Remove the screws from the battery cover. Remove the battery cover.
- Pull out the old battery carefully. Press the latch and release the connectors.  
Note: Do not pull on the cables. Hold the connectors and release the latch.
- Connect a new original battery by connecting the connectors until they click into position.
- Position the battery as shown, put the cover back in position and tighten the screws.

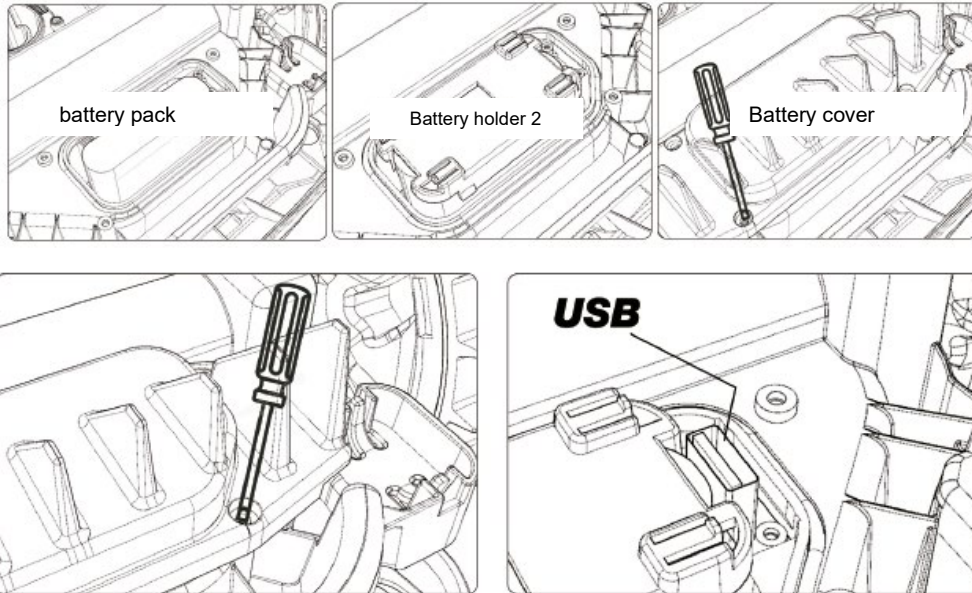

## 10.CONNECT APP

The robotic lawnmower is an IOT (Internet Of Things) device. To get the full functionality of your robotic lawnmower and to always keep it up to date with the latest software, it must be connected to the Internet via your Wi-Fi or Bluetooth 4.0.

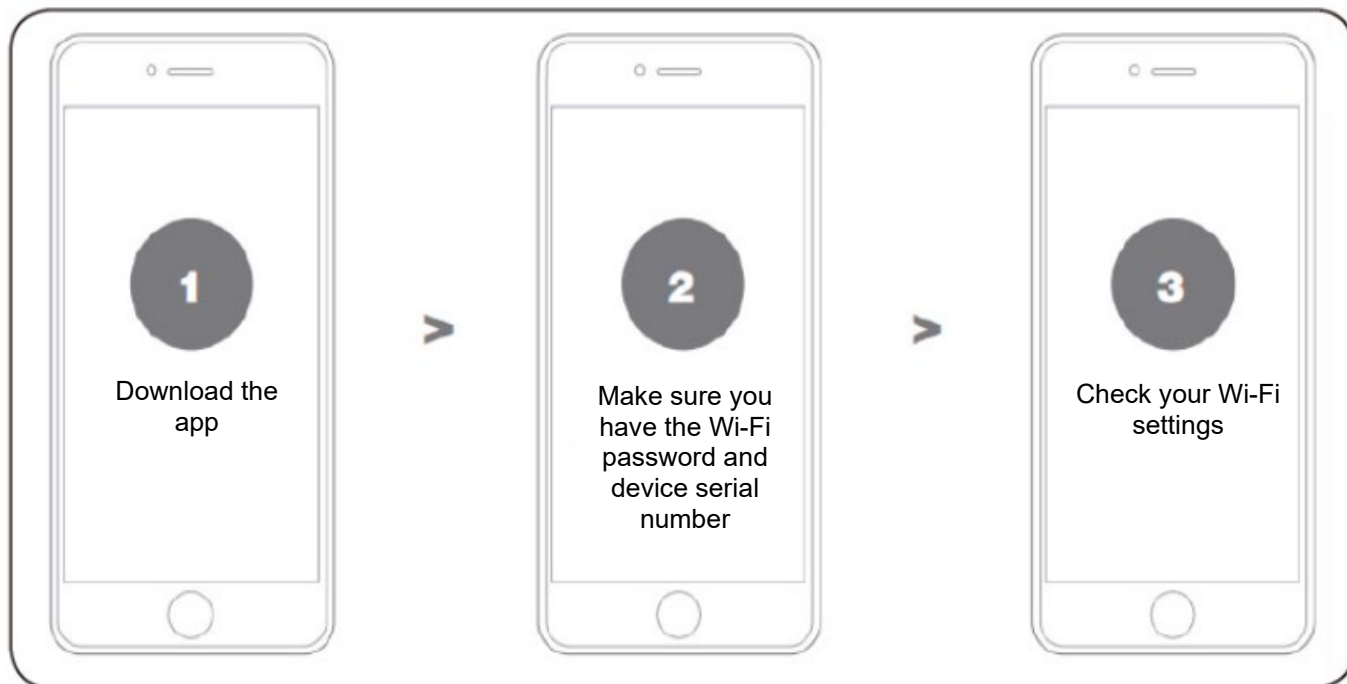

### Download the app



Please download the free app of the robotic lawnmower first, get it from Android (4.4.2 or higher) or others like App Store (iOS 11 or higher).

### Make sure you have:

- Your WIFI network password.
- Serial number of the robotic lawnmower. It can be found on the label under the rear hood of the machine.
- If you don't want to write down the serial number, enter it by scanning the QR code on the label with your phone's camera.

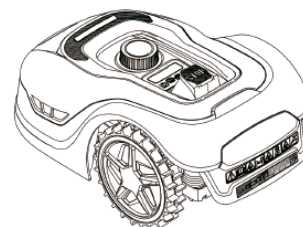

### Check your WIFI settings

- The robotic lawnmower works with 2.4 GHz.
- Make sure your lawn robot and your phone are connected in the same network environments (router).

- Make sure the distance between your robotic lawnmower, phone and router is as close as possible during connection.

NOTE: When the robot moves to an area of your lawn with poor or no WIFI signal, the instructions sent from the app will only be executed when the mower returns to an area with a good signal.

## How to connect the robot to the internet

Launch the app and follow these instructions

This application is an integral part of the functionalities of your cloud-based robotic lawnmower. Once connected, the robotic lawnmower can access its unique self-programming instructions from the cloud and can download the latest software to optimize its performance.

From the App you can:

- Start and stop the operation of your robot.
- Schedule the days and hours of work.
- Set the frequency of edge cutting.
- Configure starting zones.
- Rename your robotic lawnmower.
- Set the rain delay interval.
- Calibrate your time zone.
- Update the software and check for updates.
- Access the log of events and daily course of work.
- See the battery percentage.
- Control at all times the working status of your robotic lawnmower.
- You can also control multiple robot units simultaneously with the same account.

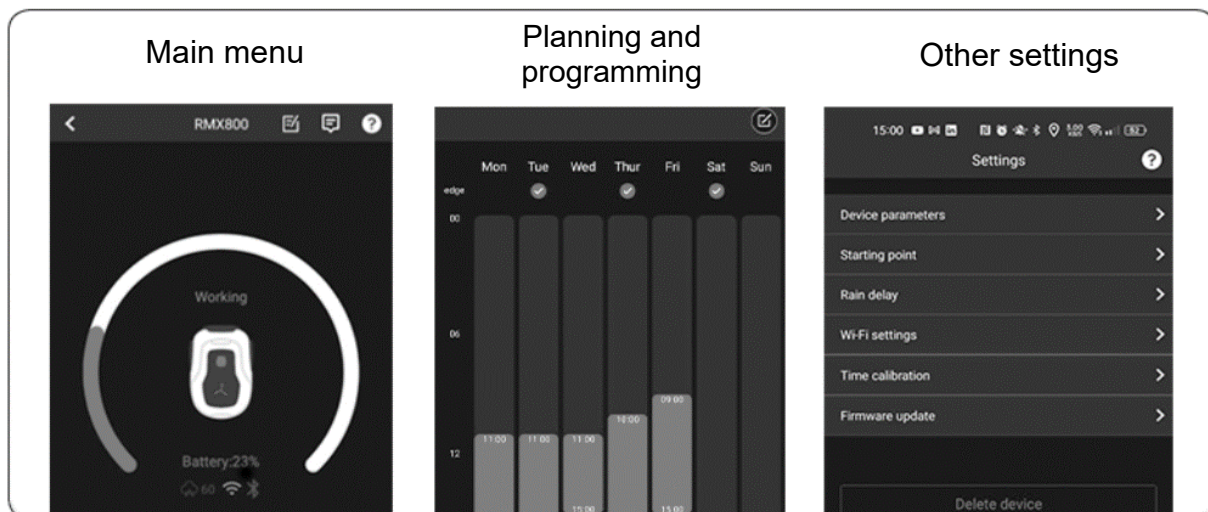

1. Register your account

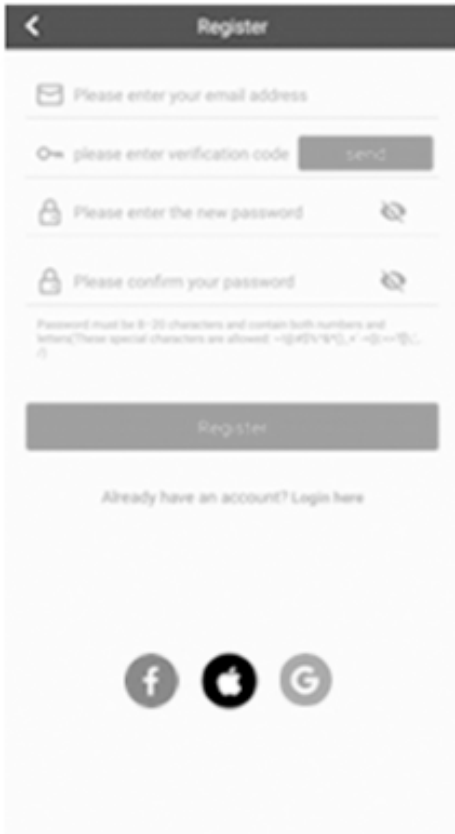

2. Add your robot using the QR code you have on the sticker



3. Enter the default pin of your robot (0000)



4. Network connection (Wi-Fi)



## APP commands:

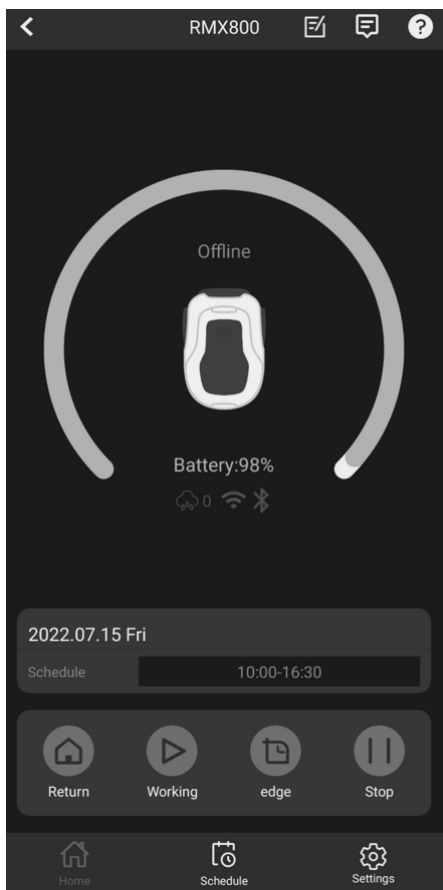

Access to sending reports and contact with the manufacturer.



Access to event log and work history.



Explanatory tutorial of the main commands.

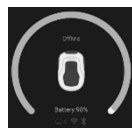

General report of the status of the robot. Battery level, connection, connection type and rain indicator.

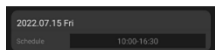

Next scheduled job.



If the robot is cutting, return to base order. You must press Stop first.



If the robot is in base, order to start cutting.



If the robot is in base, command to cut perimeter edges.



If the robot is cutting, stop order.



Access to home screen and general status.



Access to work calendar programming.



Access to secondary settings: name, starting point, rain delay, Wi-Fi settings, time setting, software updates.

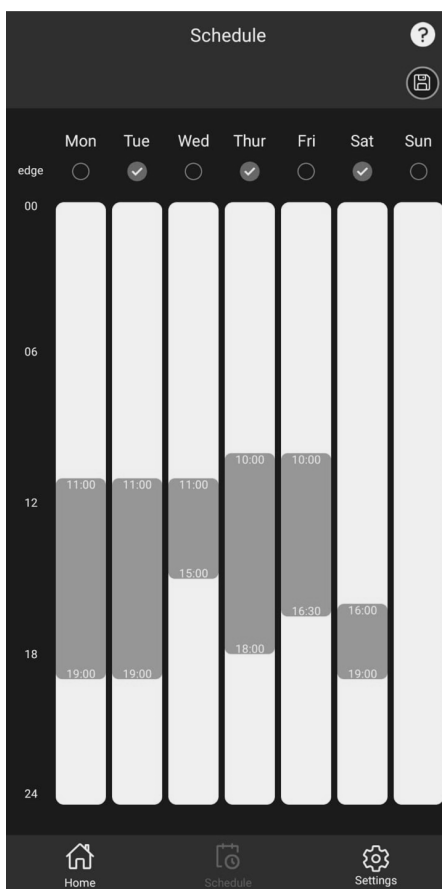
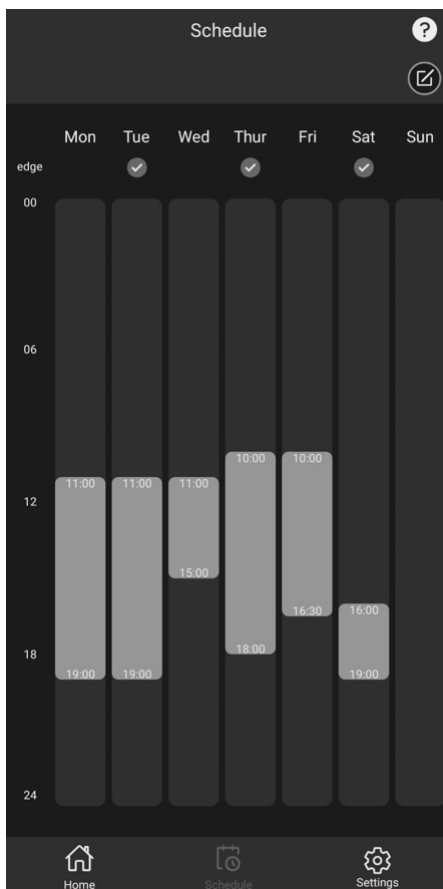

Button to edit programming.



Button to save programming.

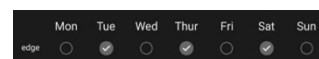

List of days to cut along the edges.

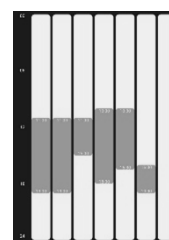

Work start and end time setting screen per day. It can be adjusted by touching the bar or by pressing and setting an exact date.

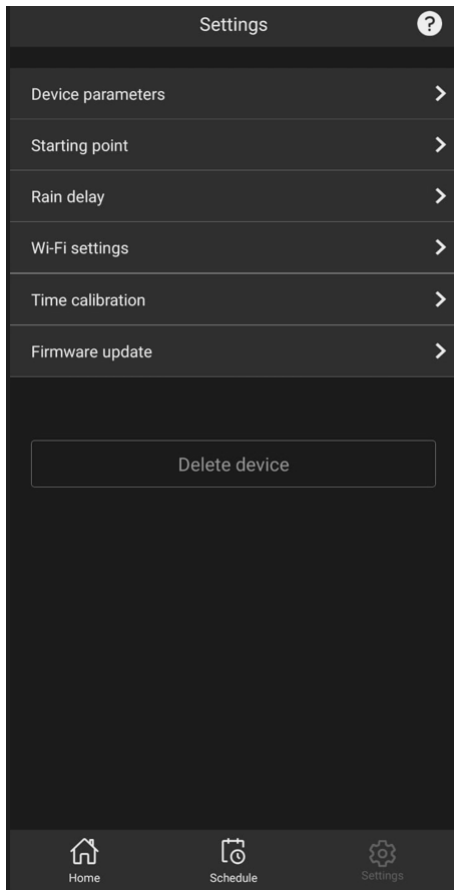

Device parameters >

Access to data about the robot: name, model and serial number.

Starting point >

Access to start point settings. It has 4 options to configure different start points per work session. They are indicated in % of the total perimeter.

Rain delay >

Access to the Rain Delay Interval setting.

Wi-Fi settings >

Access to wi-fi configuration and network identification.

Time calibration >

Access to time settings according to location and time zone.

Firmware update >

Access to search for updates.

## 11. ENVIRONMENT



Dispose of your device in an ecological way. We must not dispose of machines together with household waste. Its plastic and metal components can be sorted according to their nature and recycled. The materials used to pack this machine are recyclable. Please do not dispose of the packaging in household waste. Please dispose of these packages at an official waste collection point.

## 12. WARRANTY CONDITIONS

### App

- The warranty ensures service coverage in all applicable cases, although the machine must be accompanied by its respective purchase invoice and be managed through an authorized Anova center.

Your warranty is subject to the following conditions:

- The tool has not been misused, neglected, modified or repaired by anyone other than an authorized service center.
- Only original robotic lawnmower parts and accessories have been used in or with the product.
- The tool has worked under normal conditions without excessive demands.
- The tool has not been used for commercial or professional purposes.
- The tool has not been used for rental purposes.
- The tool has not been damaged by foreign objects, substances or accidents.



## Exclusions

The guarantee does not cover in any case:

- Components that are subject to normal wear and tear caused by use in accordance with the operating instructions.
  - Misuse, negligence, careless operation or lack of maintenance.
  - Defects caused by incorrect use, damage caused due to manipulations carried out by personnel not authorized by Anova or use of non-original spare parts.
  - Unauthorized or improper maintenance, tampering, or overloading are excluded from this warranty, as are accessories such as light bulbs, blades, and drill bits, etc.
- 
- This warranty does not apply to accessories supplied with the tool.
  - This warranty applies only to the original purchaser and is not transferable.
  - All repairs and replacement tools will be covered by the limited warranty for the remainder of the warranty period from the date of original purchase.
  - To speed up your phone inquiry, you can contact us through our platform by providing the model number and serial number of your robotic lawnmower.
  - You can write the model number and serial number to our email.



### **ATTENTION!**

TO ENSURE MAXIMUM OPERATION AND SAFETY, READ THE INSTRUCTION BOOK CAREFULLY BEFORE USE.

# 13. EXPLODED

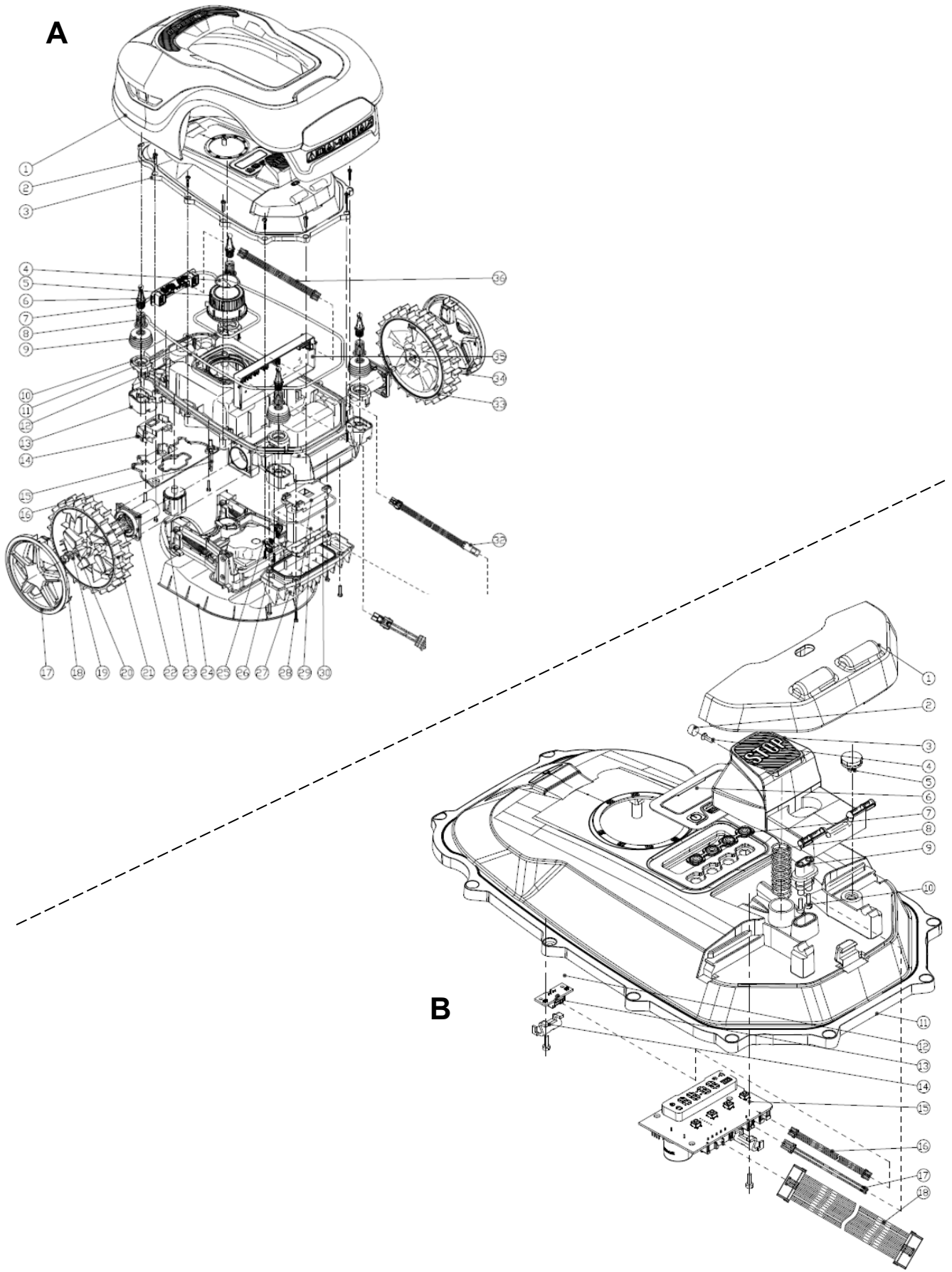

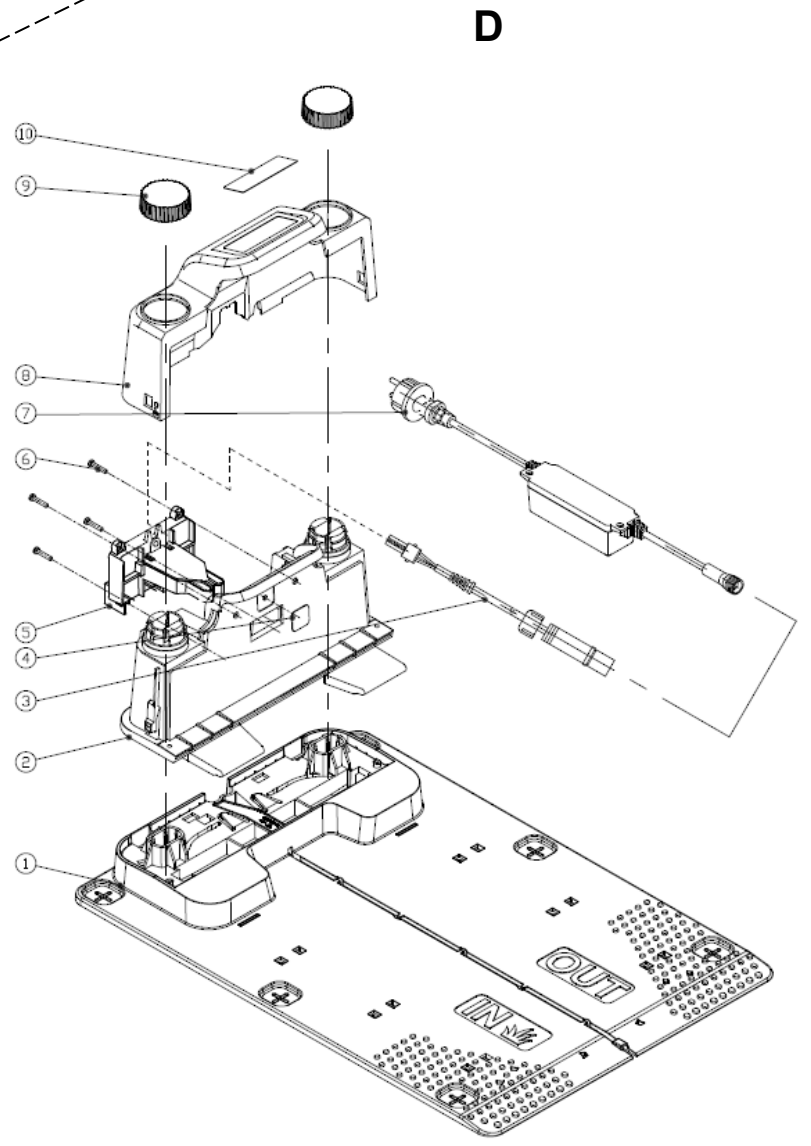
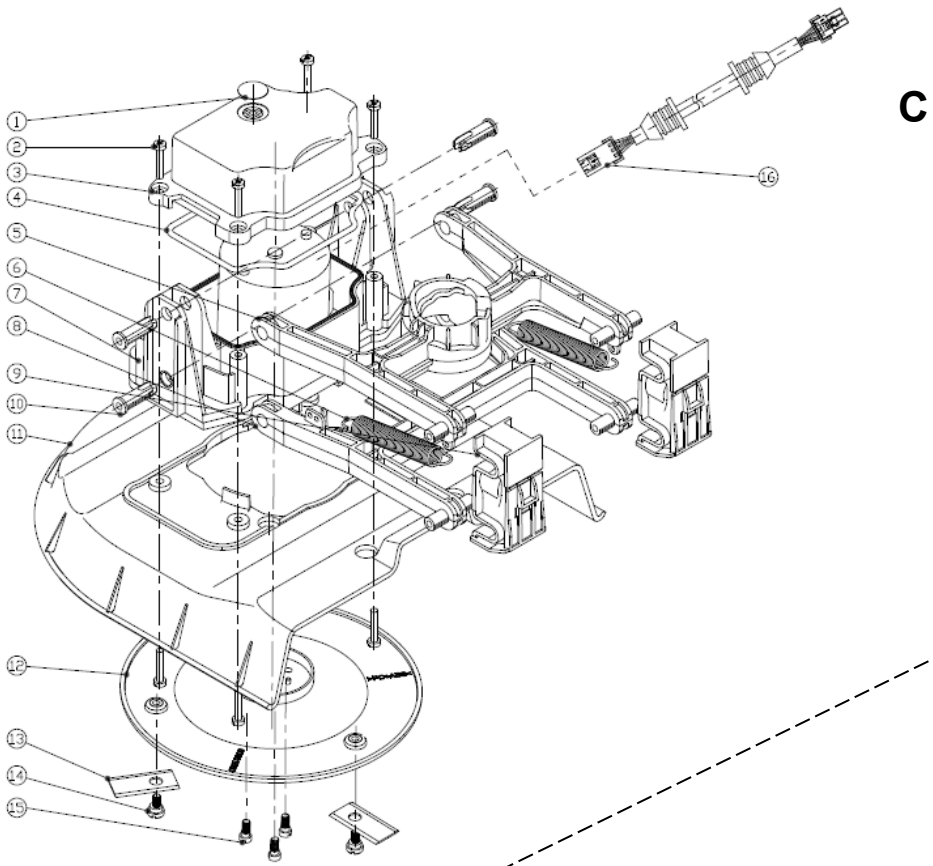

# 14.CE CERTIFICATE

## DECLARATION OF CONFORMITY (CE)

### DISTRIBUTION COMPANY

MILLASUR, SL  
RUA EDUARDO PONDAL, Nº 23 PISIGÜEIRO  
15688 OROSO - A CORUÑA  
SPAIN



## EC DECLARATION OF CONFORMITY

In compliance with the different CE directives, it is hereby confirmed that, due to its design and construction, and according to the CE mark printed by the manufacturer on it, the machine identified in this document complies with the relevant and fundamental health and safety requirements. of the aforementioned EC directives. This declaration validates the product to display the CE symbol.

In the event that the machine is modified and this modification is not approved by the manufacturer and communicated to the distributor, this declaration will lose its value and validity.

Machine name: ROBOT LAWNMOWER

Model: **RC800** (RMA801M20V)

Recognized and approved standard to which it conforms:

**2006/42/EC**  
**2014/53/EU**  
**1999/519/EC**  
**2011/65/EU**

Tested according to regulations:

**EN 50636-2-107:2015+A1:2018+A2:2020**  
**EN 60335-1:2012+A11:2014+A13:2017+A1:2019 +A2:2019+A14:2019**  
**EN 50636\_2\_107C**  
**EN 50665: 2017**  
**ENIEC 62311: 2020**  
**EN 303 447 V1.1.1 // EN 300 328 V2.2.2 // EN 300 328 V2.1.1**  
**ENIEC 55014-1:2021, EN IEC 55014-2:2021, EN IEC 61000-3-2:2019, EN 61000-3-3:2013+A1:2019**  
**EN 301 489-1 V2.2.3, EN 301 489-3 V2.1.1, EN 301 489-17 V3.2.4**

Company seal

**MILLASUR, S.L.U.**  
Rúa Eduardo Pondal,23 - Pol.EMP. Sigüeiro  
15688-Oroso-A Coruña  
Tel.(+34) 981 69 64 65 - Fax (+34) 981 69 08 61  
e-mail: millasur@millasur.com  
CIF: B-15 749 922